

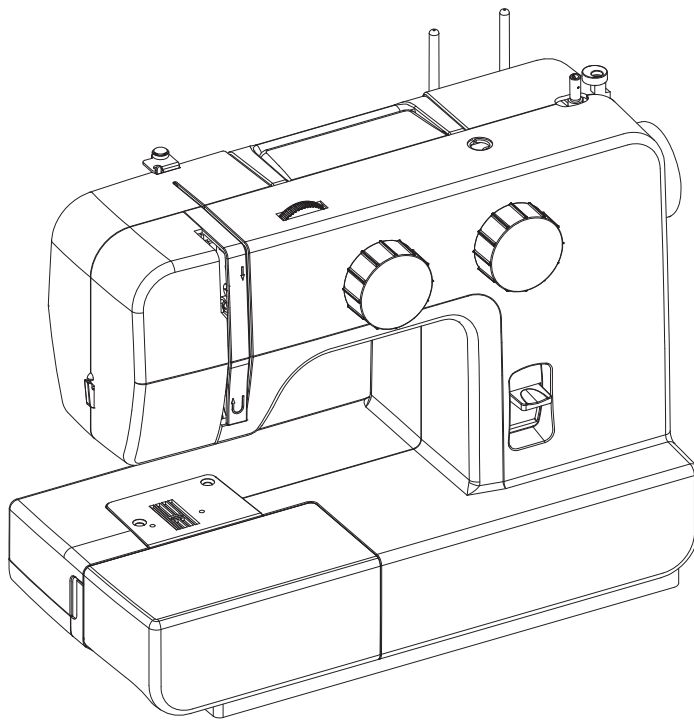

SINGER®

1412



Liste de pièces Lista de Piezas Parts List

® A registered trademark of The Singer Company Ltd. or its affiliates.
® *Una marca registrada de The Singer Company Ltd. o sus afiliados.*
® *Une marca déposée de The Singer Company Ltd. ou ses filiales.*

A

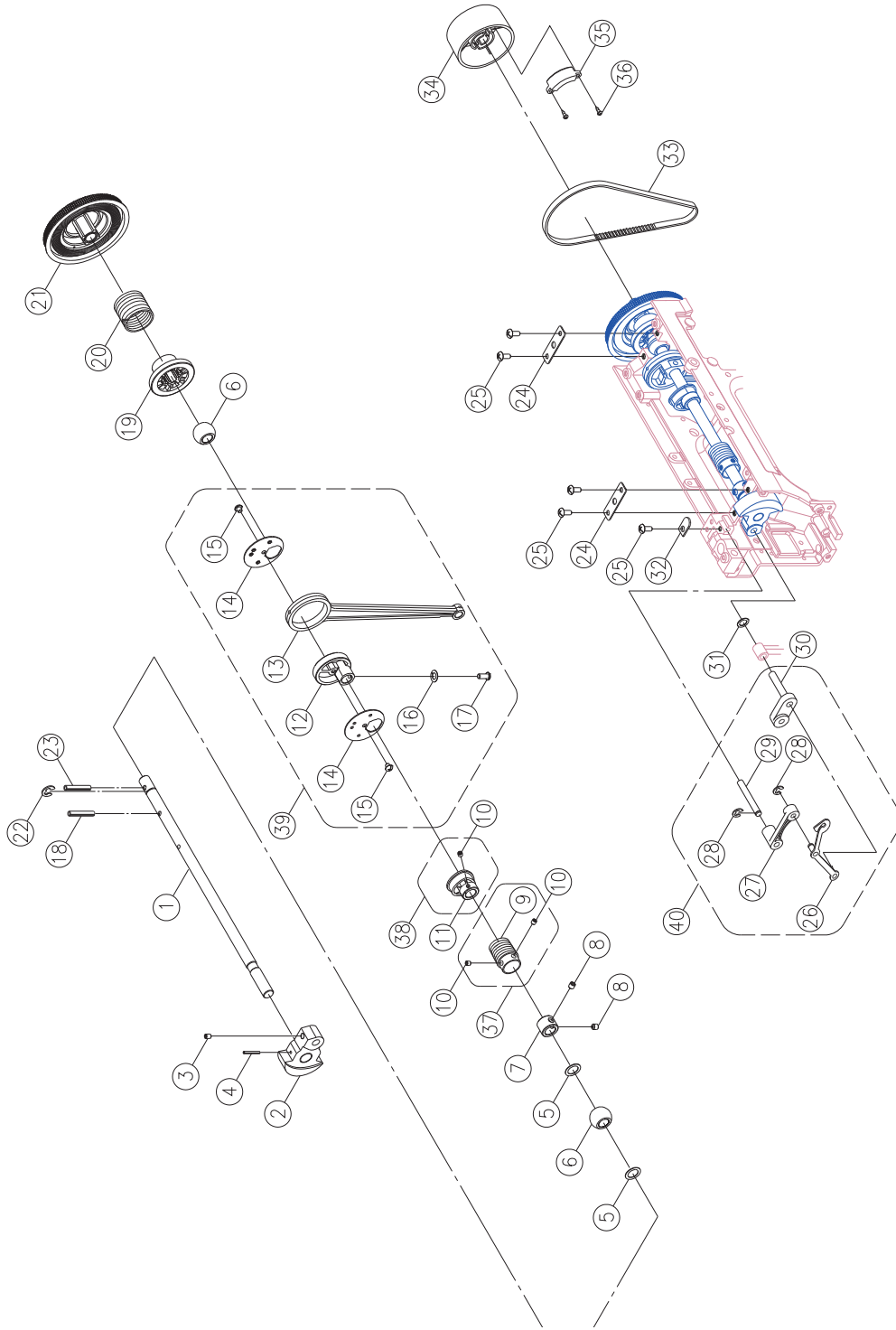

Pos	Part No.	Description
1	416516101	ARM SHAFT
2	270 V61473000	ARM SHAFT BALANCE
3	416122101	SET SCREW(M4×6 C)
4	270 003043524	ARM SHAFT BALANCE PIN (□3.5×24)
5	270 004400080	ENDURE ATTRITION WASHER (10.2×15×0.5)
6	416156301	ARM SHAFT BUSING
7	416765101	ARM SHAFT COLLAR
8	416121001	SET SCREW(M4×5 C)
9	416515201	ARM SHAFT WORM
10	416122401	SET SCREW(M4×4 C)
11	270 G4A0533000	FEED CAM
12	416604601	CRANK CONNECTING ROD CAM
13	416604601	CRANK CONNECTING ROD
14	416604601	CRANK CONNECTING ROD COVER
15	416604601	SET SCREW (M4X4 B)
16	270 004600026	WASHER(4.2×7.2×1.2)
17	270 004107063	SET SCREW(11/64×40×12)
18	270 003043028	SPRING PIN(□3×28)
19	416307201	ARM SHAFT COLLAR
20	270 D5A0573003	ARM SHAFT CLUTCH ANNULUS SPRING
21	416515301	ARM SHAFT DRIVER BELT PULLEY
22	270 003010083	E-RING (ETW-8)
23	270 003043030	SPRING PIN(□3×30)
24	416161701	ARM SHAFT BUSHING HOLDER PLATE
25	416121501	SET SCREW(M4×8 A)
26	270 E1A2513001	THREAD TAKE UP LEVER
27	416157901	THREAD TAKE UP LEVER SUPPORTER
28	416116101	E-RING (ETW-4)
29	270 V60223003	THREAD TAKE UP LEVER SUPPORTER SHAFT
30	416158001	ARM SHAFT BALANCE PIN
31	270 0044000020	ENDURE ATTRITION WASHER (6.2×12×0.25)
32	416152201	SET WASHER
33	416515401	MOTOR DRIVE BELT (250×500×5)
34	416515501	HAND WHEEL
35	270 V61893000	HAND WHEEL BALANCE LUMP
36	270 004230216	SET SCREW (M3×8.5)
37	416515601	ARM SHAFT WORM COMPLETE
38	270 G4A0535000	FEED CAM COMPLETE
39	416604601	CRANK CONNECTING ROD COMPLETE
40	270 E1A2534000	THREAD TAKE UP LEVER COMPLETE

B

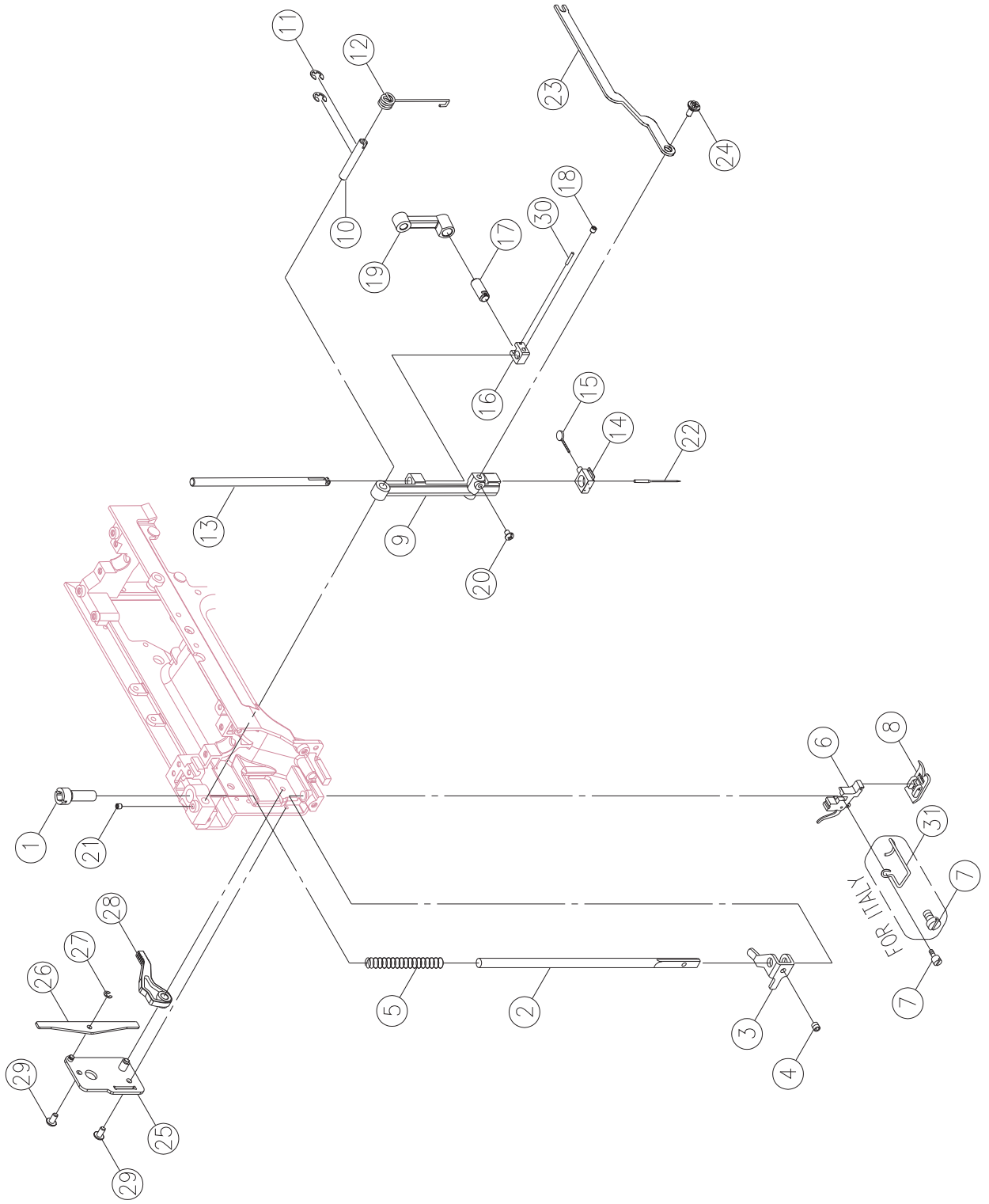

Pos	Part No.	Description
1	416515701	PRESSER BAR REGULATING SCREW
2	416173401	PRESSER BAR
3	270 H1A0093003	PRESSER BAR BRACKET
4	416122101	SET SCREW(M4×6 C)
5	270 E1A2493003	PRESSER BAR SPRING
6	416128201	SHANK COMPLETE
7	416118401	SHANK SCREW (9/64×40×8)
7	416765601	SHANK SCREW (9/64×40×9.5) FOR FINGER PROTECTOR
8	416128401	ALL PURPOSE FOOT
9	270 V61973002	NEEDLE BAR SUPPORTER
10	416515801	NEEDLE BAR SUPPORTER PIN
11	416116301	E-RING (ETW-5)
12	416515901	NEEDLE BAR SUPPORTER SPRING
13	416173601	NEEDLE BAR
14	416245301	NEEDLE CLAMP
15	416245301	NEEDLE CLAMP SCREW
16	416638901	NEEDLE BAR BRACKET (1)
17	416771501	NEEDLE BAR BRACKET (2)
18	416122401	SET SCREW(M4×4 C)
19	416639101	NEEDLE BAR CRANK ROD
20	270 004106202	SET SCREW(9/64×40×7A)
21	416121001	SET SCREW(M4×5 C)
22	270 006176008	NEEDLE
23	416516001	NEEDLE BAR DRIVING ROD
24	416408701	NEEDLE BAR DRIVING ROD PIN
25	270 H1A0053003	CLAMP PLATE
26	270 H1A0063003	TENSION LEVER LIFTER
27	416116001	E-RING (ETW-3)
28	416793801	PRESSER BAR LIFTER LEVER
29	416121501	SET SCREW (M4×8 A)
30	416572001	PIN (□2×12)
31	416765801	FINGER PROTECTOR FOR ITALY

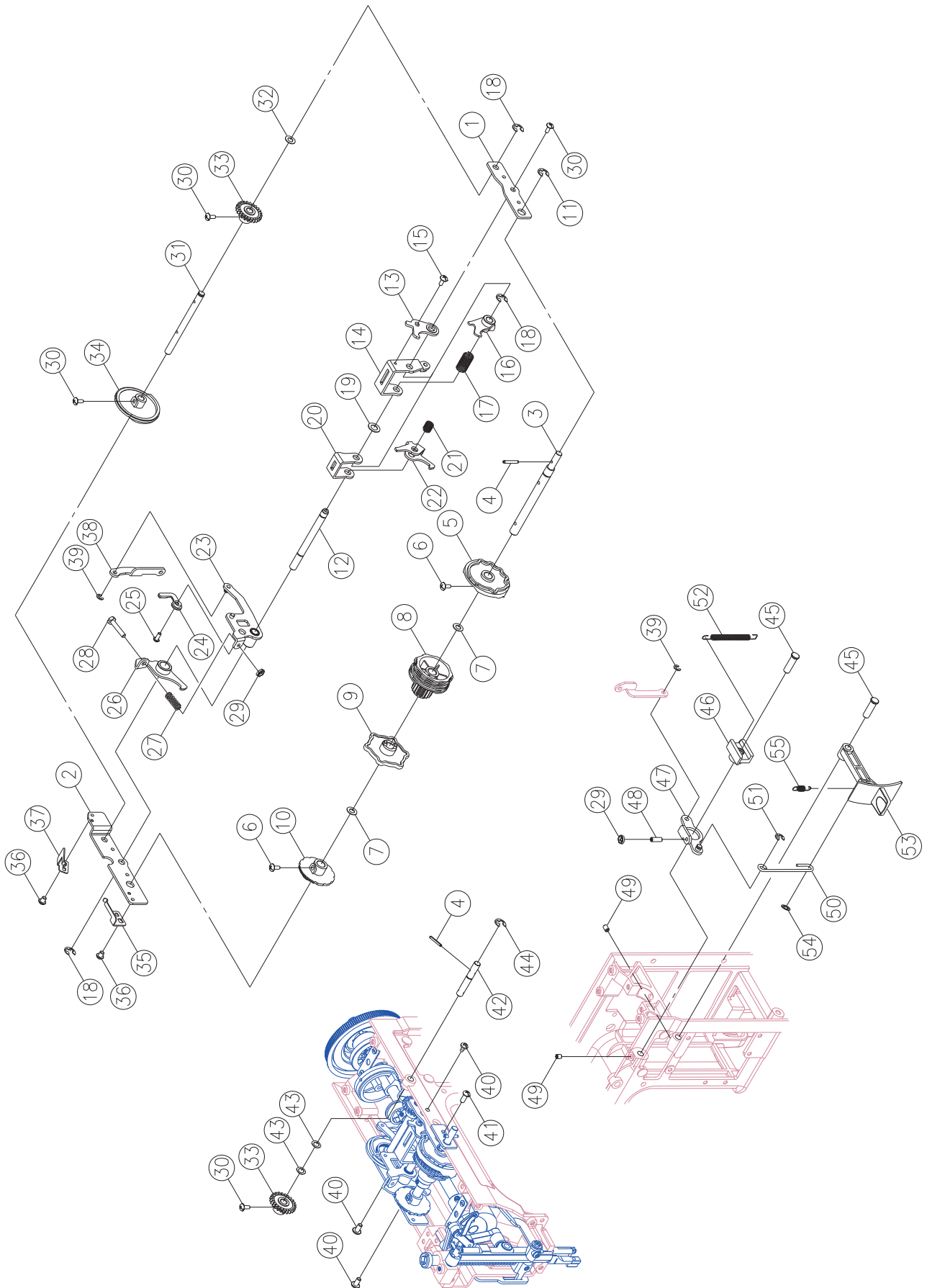

Pos	Part No.	Description
1	416516301	PATTERN CAM CONTACT PLATE (FRONT)
2	M2A6013003	PATTERN CAM CONTACT PLATE (BACK)
3	416516701	PATTERN SELECTOR CAM SHAFT
4	416183901	SPRING PIN (□2.5×16)
5	416796801	PATTERN SELECTOR CAM
6	270 004235016	SET SCREW (M3.5×8A)
7	416186501	WASHER (□8.2×□12×0.5)
8	416517001	PATTERN CAM
9	416793901	SS CAM
10	416794001	BH PATTERN SELECTOR CAM
11	416116401	E-RING (ETW-6)
12	416517301	CONTACT SUPPORTER SHAFT
13	416517401	ZIGZAG RELEASE PLATE
14	416794101	ZIGZAG CAM CONTACT SUPPORTER COMPLETE
15	416119201	SET SCREW (M3×6A)
16	416517701	ZIGZAG CAM CONTACT
17	416517801	ZIGZAG CAM CONTACT SPRING
18	270 003010056	E-RING (ETW-5)
19	416125601	ENDURE ATTRITION WASHER (□6.7×□11.8×0.5)
20	416794201	SS CAM CONTACT SUPPORTER
21	416794301	SS CAM CONTACT SPRING
22	416794401	SS CAM CONTACT
23	416794501	FEED CRANK COMPLETE
24	416794601	SS ADJUSTING BUTTON
25	416119701	SET SCREW (M3×8B)
26	416796901	BH REGULATOR PLATE COMPLETE
27	270 V60813003	BH SPRING
28	270 004240706	SET SCREW (M4×20)
29	416126801	NUT (ALN-4)
30	416518401	SET SCREW (M3×8 A)
31	416794701	FEED REGULATOR CAM SHAFT
32	270 004900063	WASHER (□6.2×□12×2.0×0.15)
33	416518301	FEED REGULATOR GEAR
34	416808401	FEED REGULATOR CAM
35	416518901	PATTERN FIX SPRING PLATE
36	416226601	SET SCREW (M4×5 B)
37	416794901	FEED REGULATOR SET PLATE
38	416518701	FEED ROD
39	416116001	E-RING (ETW-3)
40	416121501	SET SCREW (M4×8 A)
41	416121101	SET SCREW(M4×10 B)
42	416519001	STITCH LENGTH DIAL SHAFT
43	416186801	WASHER (□6.5×□10.5×1.5×0.15)
44	416116301	E-RING (ETW-5)
45	270 V60443000	FEED REGULATING SHAFT
46	416519101	FEED REGULATING
47	416519201	FEED REGULATING PLATE COMPLETE
48	416122701	SET SCREW (M4×12)
49	416122101	SET SCREW(M4×6 C)
50	416519401	REVERSE ROD
51	270 003010046	E-RING (ETW-4)
52	270 V70063003	FEED REGULATING SPRING
53	416519501	REVERSE LEVER BUTTON
54	270 003020043	CS-RING (CSTW-4)
55	416155001	AUTO THREADER LEVER SPRING

D

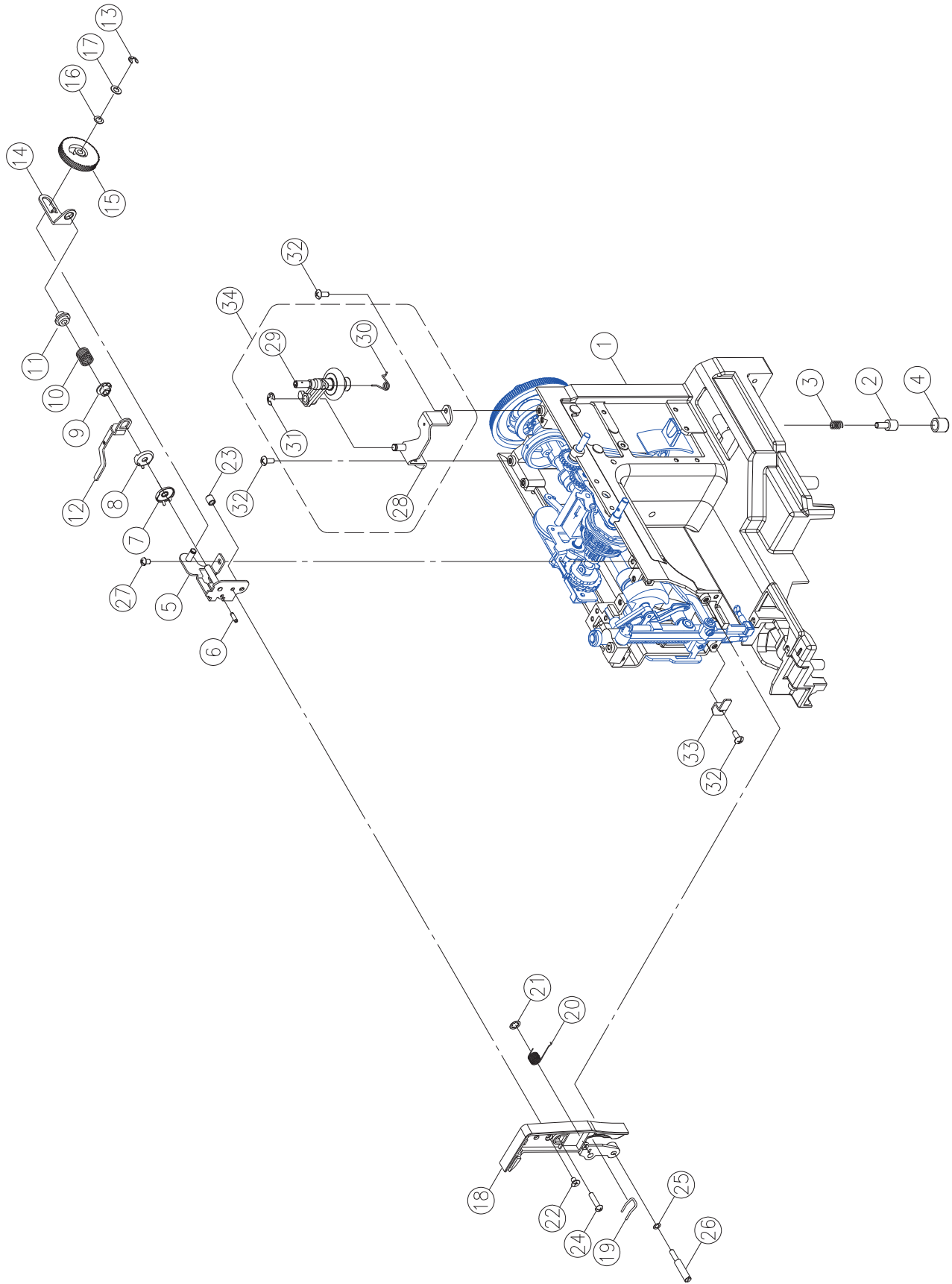

Pos	Part No.	Description
11	416771901	ARM
2	416154601	BASE PLATE ADJUSTMENT SCREW
3	416154401	BASE PLATE ADJUSTMENT SCREW SPRING
4	416152901	FREE ARM BASE CUSHION RUBBER
5	416735001	DIAL TENSION SUPPORTER PLATE COMPLETE
6	416117501	SPRING PIN (□3×10)
7	416153601	DIAL TENSION DISC (1)
8	416146301	DIAL TENSION DISC
9	416526801	DIAL TENSION SPRING REGULATOR
10	416772201	DIAL TENSION SPRING
11	416153801	DIAL TENSION REGULATOR
12	416772101	DIAL TENSION WAFT PLATE
13	416116101	E-RING (ETW -4)
14	270 V60273006	DIAL TENSION SPRING PLATE
15	416498301	DIAL TENSION KNOB
16	416126001	WASHER (WW-5)
17	416124501	WASHER (5.2×10×0.5)
18	416795001	DIAL TENSION SUPPORTER PLATE COVER
19	416198701	THREAD GUIDE
20	270 V60303000	THREAD GUIDE SPRING
21	416116701	CS-RING (CSTW-5)
22	416121901	SET SCREW (M4×6D)
23	416151701	DIAL TENSION GUIDE SPRING TUBE
24	270 004240746	SET SCREW (M4×18B)
25	416124101	WASHER (4.2×8×0.8)
26	270 004240982	SET SCREW (M4×14 L=37)
27	416121201	SET SCREW (M4×6B)
28	416772501	BOBBIN WINDER FRAME COMPLETE
29	416520201	BOBBIN WINDER CRANK COMPLETE
30	270 K6A0573003	BOBBIN WINDER CRANK SPRING
31	416116301	E-RING (ETW-5)
32	416121501	SET SCREW (M4×8 A)
33	416520301	NEEDLE BAR STOP PLATE
34	416795101	BOBBIN WINDER COMPLETE

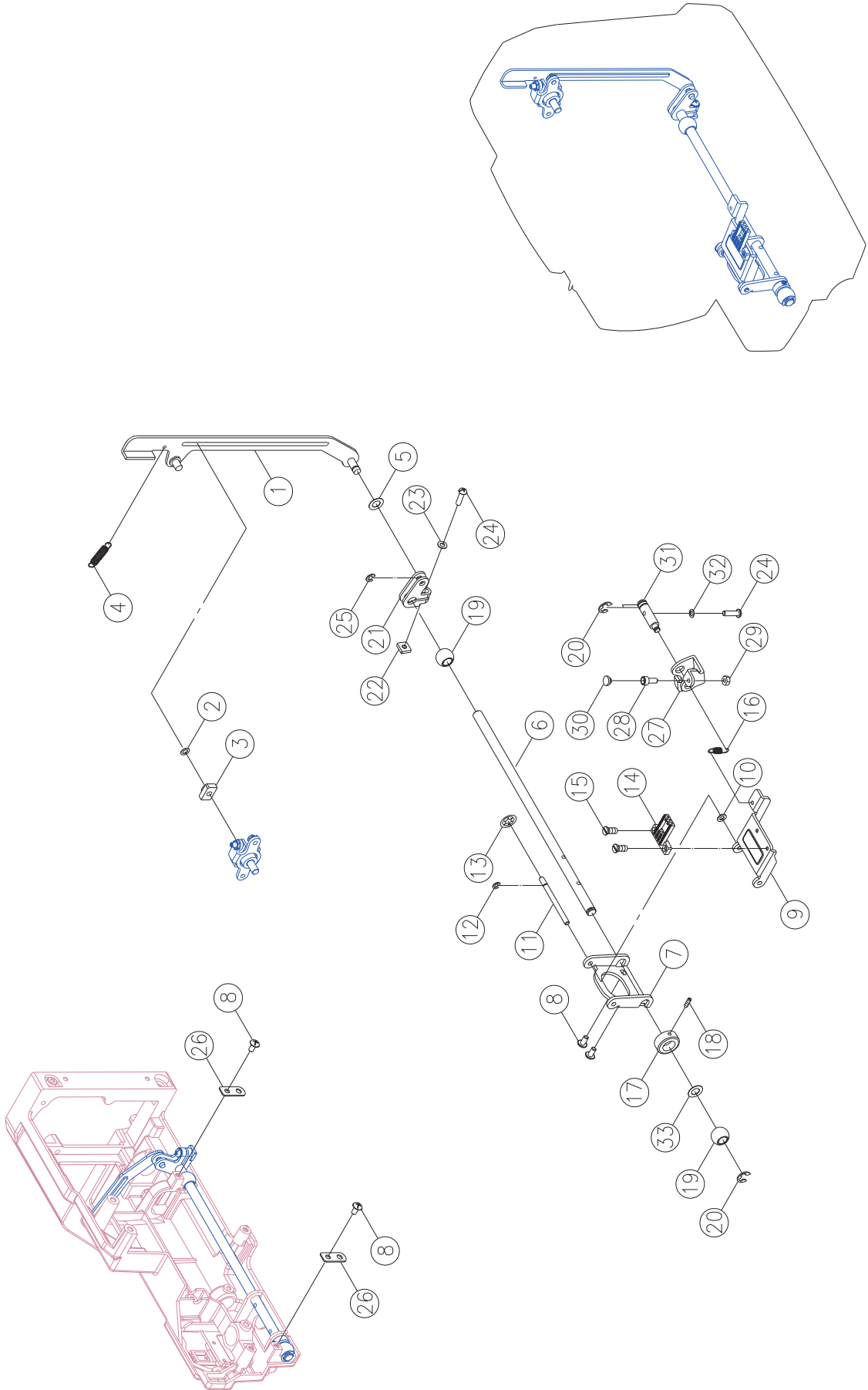

Pos	Part No.	Description
1	270 V60453003	FORK ROD
2	270 004400180	ENDURE ATTRITION WASHER (5.7×10.2×0.5)
3	270 V11533000	FEED REGULATING BLOCK
4	416795201	FORK ROD SPRING
5	270 004400450	ENDURE ATTRITION WASHER (5.5×12×0.25)
6	416520501	FEED ROCK SHAFT
7	270 V60493003	FEED ROCK FRAME
8	416121501	SET SCREW (M4×8 A)
9	270 V60503003	FEED DOG FRAME
10	416124101	WASHER (4.2×8×0.8)
11	270 V60513003	FEED DOG FRAME SHAFT
12	416116001	E-RING (ETW-3)
13	270 003090043	NUT (SPN-4)
14	416171601	FEED DOG
15	270 004230056	SET SCREW (M3×5 B)
16	270 V60533003	FEED DOG FRAME SPRING
17	416151901	PATTERN CAM SHAFT COLLAR
18	416122401	SET SCREW (M4×4 C)
19	270 V60343000	FEED ROCK BUSHING
20	416116401	E-RING (ETW-6)
21	270 V60553003	FEED ROCK CRANK
22	270 004840073	FEED ROCK CRANK NUT (M4)
23	270 004300093	WASHER (4×8×0.5)
24	416121701	SET SCREW (M4×15 B)
25	416116101	E-RING (ETW-4)
26	270 V60563003	BUSHING HOLDER PLATE
27	270 V60583003	FEED LIFTING ROCK CRANK
28	270 004250323	SEW SCREW
29	270 004840022	NUT (M4 T=3)
30	270 K81243000	SEW SCREW KNOB
31	270 V60593003	FEED LIFTING ROCK SHAFT
32	270 004600026	Washer (4.2×7.2×1.2)
33	270 004400410	ENDURE ATTRITION WASHER (8.2×12×0.25)

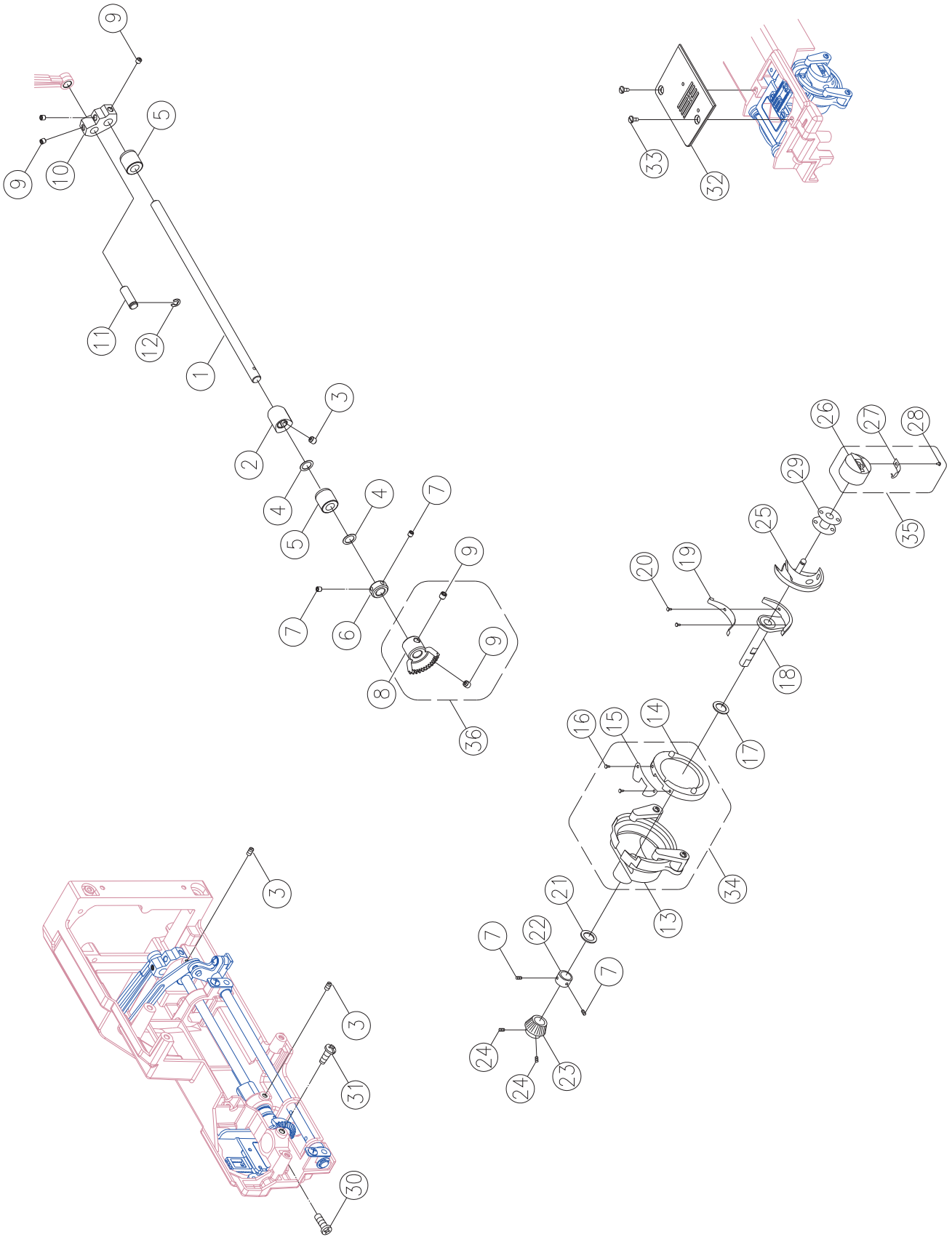

Pos	Part No.	Description
1	416527801	LOWER SHAFT
2	270 V6E1123000	FEED LIFTING ROCK CAM
3	416122101	SET SCREW (M4X6C)
4	270 004400410	ENDURE ATTRITION WASHER (8.2X12X0.25)
5	416141701	FEED ROCK BUSHING
6	416520801	LOWER SHAFT COLLAR
7	416122401	SET SCREW (M4X4C)
8	270 G4A1573000	LOWER SHAFT GEAR
9	270 004250203	SET SCREW (M5X5C)
10	270 V60363000	CRANK CONNECTING ROD CRANK
11	270 V10833003	CRANK CONNECTING ROD CRANK PIN
12	416116301	E-RING (ETW-5)
13	270 V10995000	OPEN SHUTTLE RACE
14	270 V115730012	SHUTTLE HOOK HOLDER
15	270 V10995000	SHUTTLE HOOK HOLDER SPRING
16	416153001	SHUTTLE HOOK HOLDER SPRING SCREW
17	270 004400800	ENDURE ATTRITION WASHER (7.6×12×0.13)
18	270 K81125000	SHUTTLE DRIVER
19	270 K81125000	SHUTTLE DRIVER SPRING
20	270 K81125000	SHUTTLE DRIVER SPRING SCREW
21	270 004400210	ENDURE ATTRITION WASHER (8.2×16×0.5)
22	270 G2D0325000	SHUTTLE DRIVER SHAFT COLLAR
23	270 G4A1583000	SHUTTLE DRIVER SHAFT GEAR
24	270 004107293	SET SCREW(11/64×40×4)
25	416392101	SHUTTLE HOOK
26	416153501	BOBBIN CASE
27	270 H13803001	BOBBIN CASE SPRING
28	416153501	BOBBIN CASE SPRING SET SCREW
29	270 006084009	BOBBIN
30	416121101	SET SCREW (M4X10B)
31	270 004250151	SET SCREW (M5X10B)
32	416171501	NEEDLE PLATE
33	416122901	NEEDLE PLATE COMPLETE SET SCREW
34	270 V10995000	OPEN SHUTTLE RACE COMPLETE
35	416153401	BOBBIN CASE COMPLETE
36	416245801	LOWER SHAFT GEAR COMPLETE

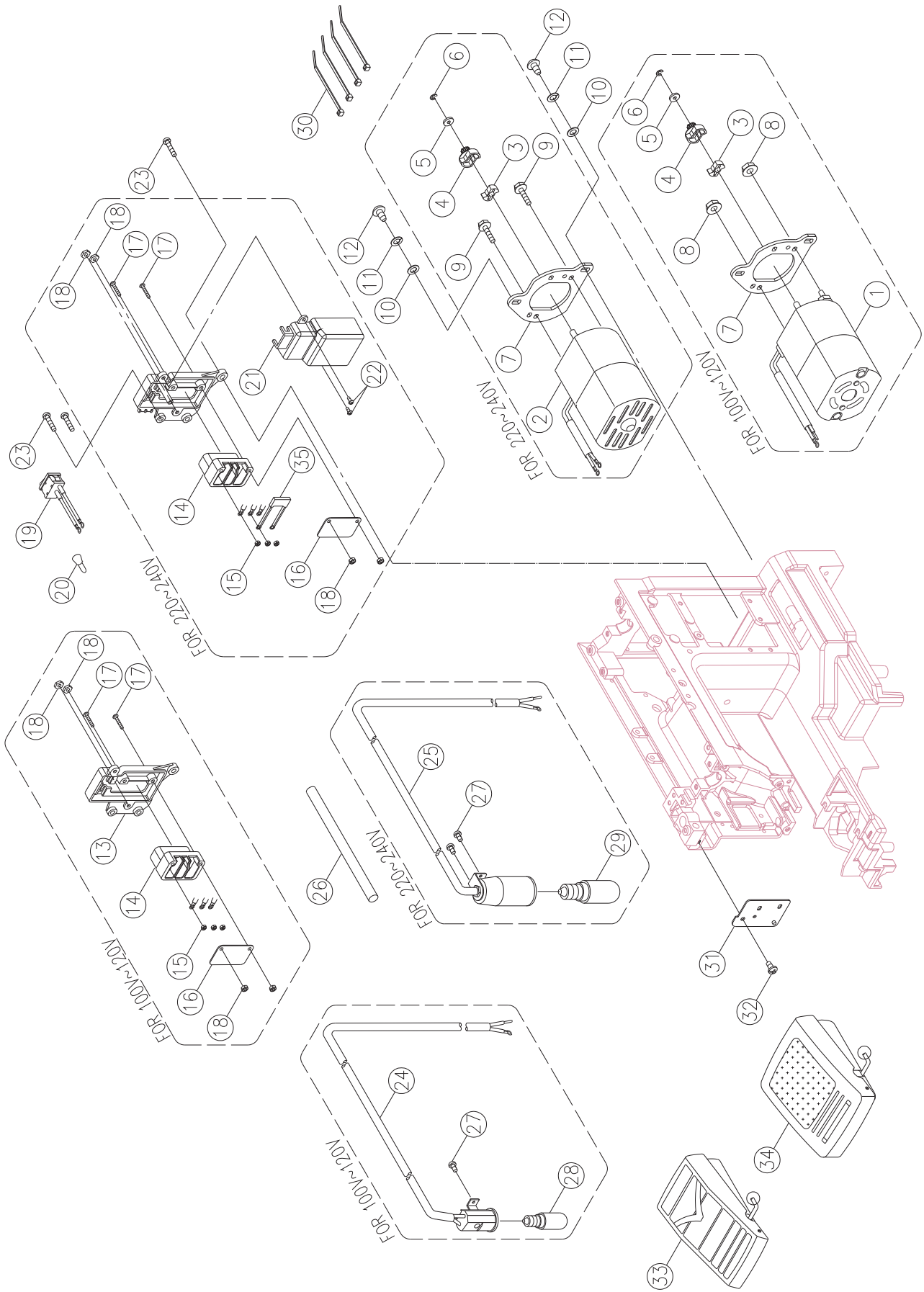

ALL VOLTAGE APPLICATION & SPEC. . PLEASE CHECK NEXT PAGE.

Pos	Part No.	Description
1	416795301	MOTOR FOR 100V /JAPAN
1	416521101	MOTOR FOR 120V /US.
2	416795401	MOTOR FOR 220V /KOREA
2	416795501	MOTOR (HF-07250) FOR 230V /SAUDI ARABIA
2	416521201	MOTOR FOR 230V /EU.
2	416795601	MOTOR (HF-07250) FOR 230V /DUBAI
2	416795701	MOTOR (HF-07250) FOR 240V /U.K
2	416795801	MOTOR (HF-07250) FOR 240V /SAA
3	416129401	CUSHION RUBBER
4	416428701	BELT WHEEL
5	416114001	MOTOR FEED REGULATOR COLLAR
6	416116001	E-RING (ETW-3)
7	416521401	MOTOR BRACKET
8	270 004840131	NUT (M4 T=5.5) FOR 100V~120V
9	416521501	SET SCREW (M4×10.2) FOR 220V-240V
10	004300306	WASHER (5.4×10×0.9)
11	004600296	SPRING WASHER (5.2×9×1)
12	416224801	SET SCREW (M5×12)
13	416772801	RECEPTACLE HOLDER FOR 100V~120V
13	416795901	RECEPTACLE HOLDER FOR 220V~240V
14	002624129	RECEPTACLE
15	270 004840120	NUT (M3×4)
16	416183601	CONCERT INSULATION PLATE
17	004230865	SET SCREW (M3×20)
18	416302901	NUT (M3 T=2.3)
19	416521701	SWITCH ASS' Y
20	416133001	END TERMED
21	416796001	RECEPTACLE HOLDER COVER FOR 220V-240V
22	416119201	SET SCREW (M3×6B) FOR 220V-240V
23	416121701	SET SCREW (M4×15)
24	416428401	LAMP HOLDER COMPLETE FOR 100V~120V
25	416428501	LAMP HOLDER COMPLETE FOR 220V-240V
26	270 002486000	SPAGHETTI
27	270 004230056	SET SCREW (M3×5 B)
28	416126901	LAMP (10W) FOR 120V
29	416766201	LAMP (15W) FOR 220V
29	416127001	LAMP (15W E-12) FOR 240V
30	416113901	CORD CLIP
31	416522001	LAMP BRACKET
32	416121201	SET SCREW (M4×6B)
33	416734201	FOOT CONTROLLER (KD-1902) FOR 100V/JAPAN
33	270 002V8E4003	FOOT CONTROLLER (FC-1902) FOR 120V /US
34	416732901	FOOT CONTROLLER (FC-2902C) FOR 220V /KOREA
34	416468201	FOOT CONTROLLER (FC-2902C) FOR 230V /EU.
34	416732801	FOOT CONTROLLER (FC-2902C) FOR 230V /CHINA
34	416733001	FOOT CONTROLLER (FC-2902C) FOR 230V /DUBAI
34	416733201	FOOT CONTROLLER (FC-2902C) FOR 230V /SOUTH AFRICA
34	416733401	FOOT CONTROLLER (FC-2902C) FOR 240V / U.K
34	416733501	FOOT CONTROLLER (FC-2902C) FOR 240V / SAA
35	416796101	CONDENSER FOR 100V
35	270 002441000	CONDENSER FOR 220V~240V

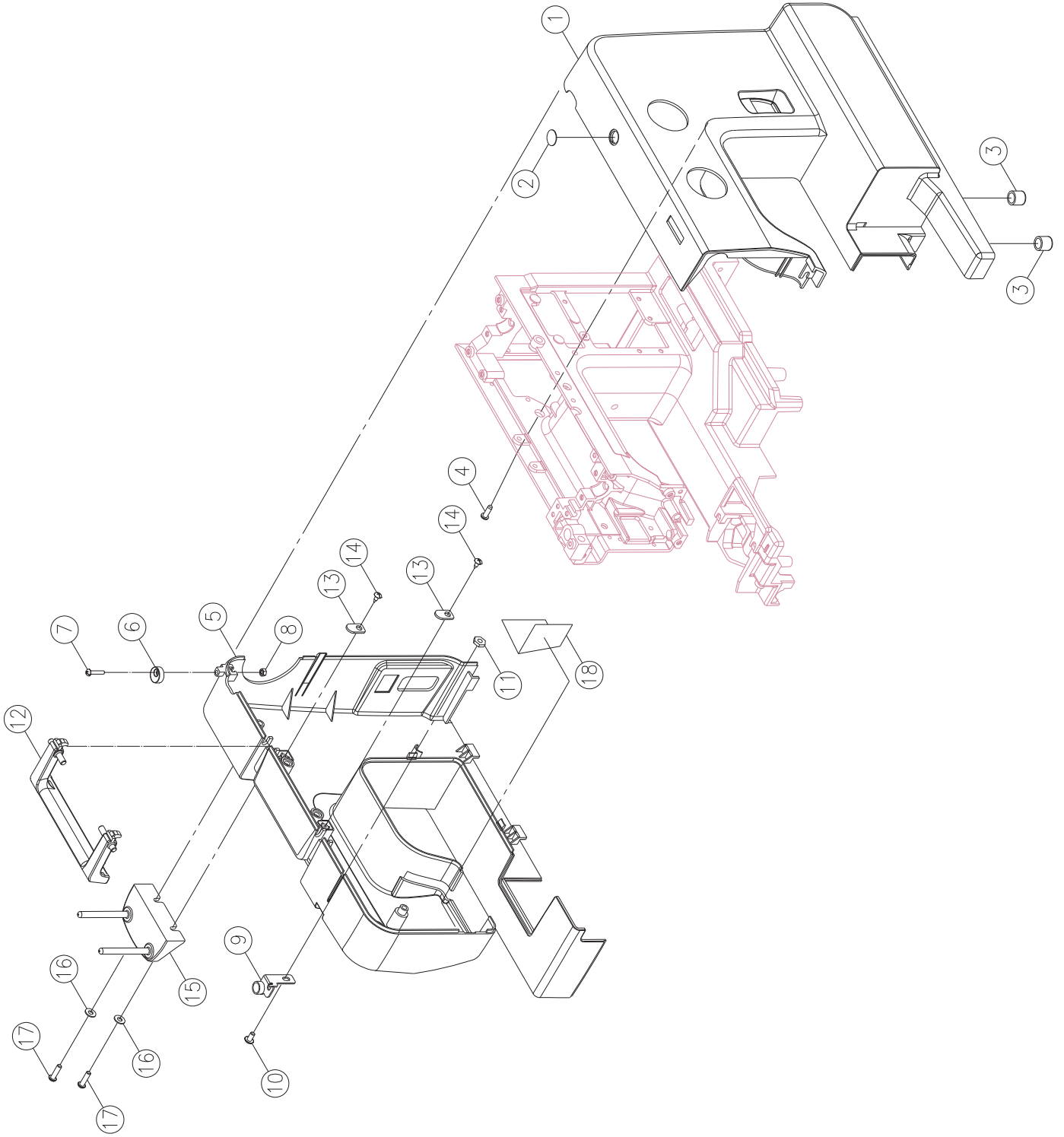

Pos	Part No.	Description
1	416796201	FRONT COVER
2	270 V61503210	PLATE (1)
3	416152901	FREE ARM BASE CUSHION RUBBER
4	270 004240526	SET SCREW (M4×12 B)
5	416796301	BACK COVER
6	270 K6B0393000	BOBBIN WINDER STOPPER
7	416174001	SET SCREW (9/64×40×16 B)
8	416126301	NUT (9/64×40 T=3)
9	270 V61325000	BOBBIN WINDER THREAD GUIDE COMPLETE
10	416121101	SET SCREW (M4×10 B)
11	270 004840022	NUT (6.8×7.8×3 M4×0.7)
12	416522601	HANDLE
13	416152201	SET WASHER
14	270 004230216	SET SCREW (M3×8.5)
15	416515001	SPOOL PIN PLATE
16	416123501	SET SCREW (M4×20 A)
17	416522701	HEAT RESISTANT PLATE

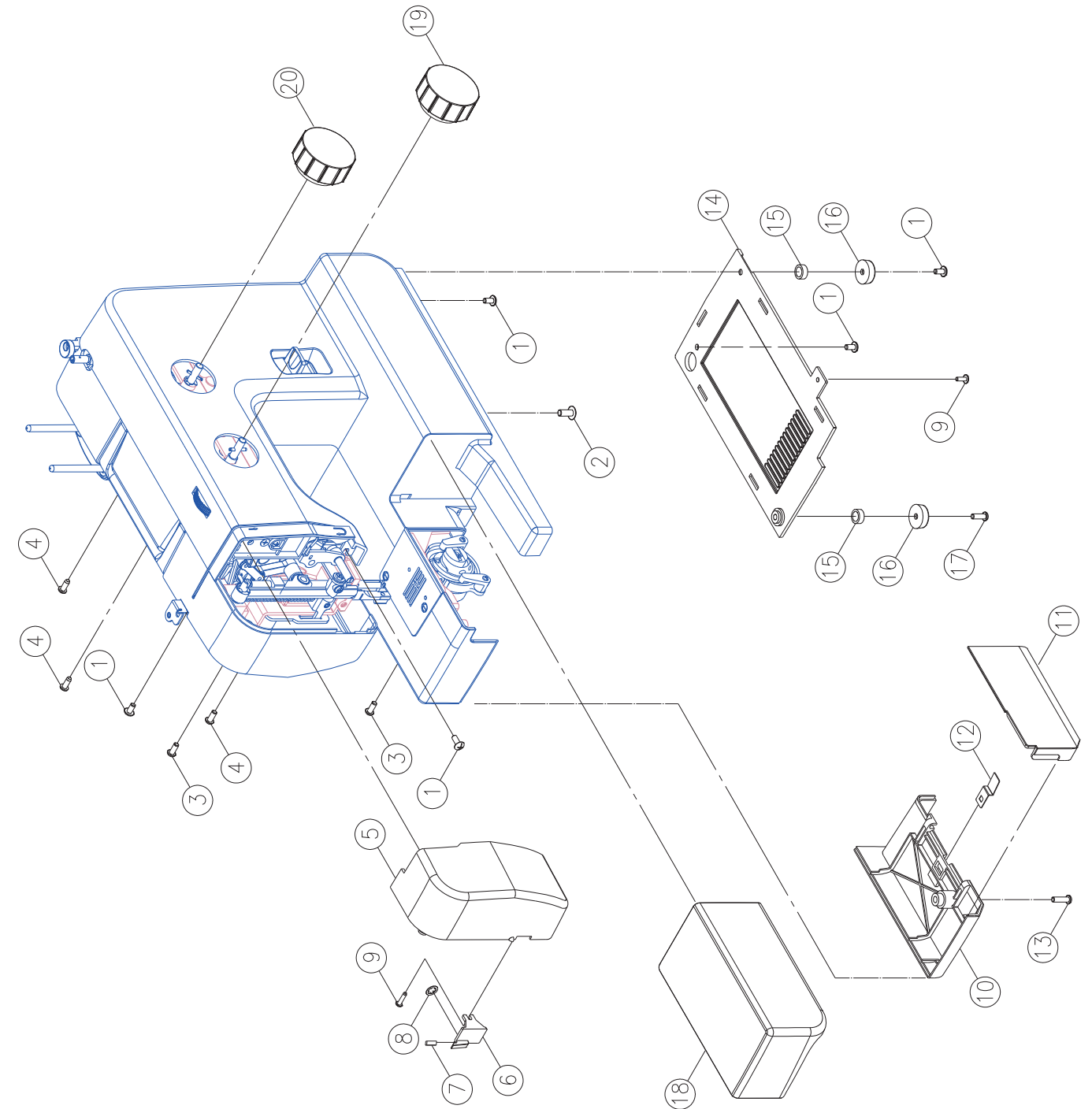

Pos	Part No.	Description
1	416121501	SET SCREW (M4×8 A)
2	416224801	SET SCREW (M5×12)
3	416121101	SET SCREW (M4×10 B)
4	416122201	SET SCREW (M4×10 B)
5	416796401	FACE PLATE
6	416522901	FACE CUTTER PLATE
7	416172501	THREAD CUTTER
8	416116701	CS-RING (CSTW-5)
9	270 004230216	SET SCREW (M3×8.5)
10	416523001	BED COVER
11	416523001	HOOK COVER
12	416421301	HOOK COVER SPRING
13	416121701	SET SCREW (M4×15 B)
14	416523201	BOTTOM PLATE
15	416542201	BUSHING
16	270 J31413000	FREE ARM BASE CUSHION RUBBER
17	416121601	SET SCREW (M4×12 B)
18	416487901	SEWING TABLE BODY
19	416796501	PATTERN SELECTOR DIAL
20	416796601	STITCH LENGTH DIAL

STANDARD ACCESSORIES

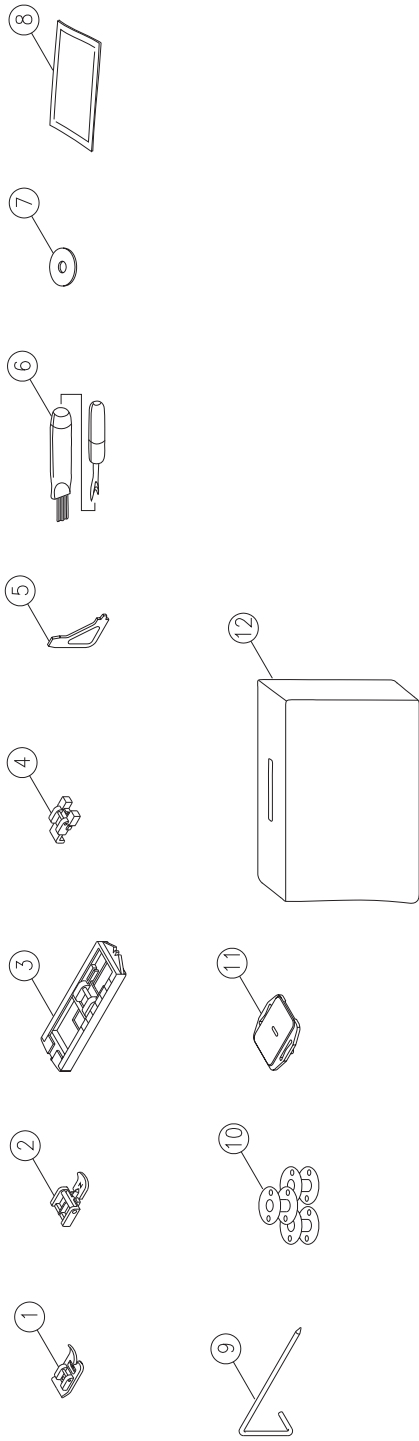

OPTIONAL ACCESSORIES



Pos	Part No.	Description
1	416128401	ALL PURPOSE FOOT
2	416128701	ZIPPER FOOT (I)
3	416128901	BUTTONHOLE FOOT (B)
4	416284501	BUTTON SEWING FOOT
5	270 006093009	L-SCREWDRIVER
6	416127701	SEAM RIPPER/ BRUSH
7	416127301	SPOOL PIN FELT
8	006V880010	PACK OF NEEDLE
9	416127101	SEAM GUIDE
10	270 006084009	BOBBIN
11	416127901	FELT PAD
12	416796701	SOFT COVER COMPLETE
OPTIONAL ACCESSORIES		
1	416129101	QUILTING FOOT
2	416284101	OVERCASTTING FOOT (G)
3	270 006800008	HEMMER FOOT
4	416128501	BLIND HEM FOOT (L)
5	270 006804008	SATIN STITCH FOOT
6	006016008	DARNING/ EMBROIDERY FOOT